

alien *e*



eurocolumbus
C-ARM EVOLUTION

*BEING THE FIRST HAS BEEN OUR VOCATION
FOR MORE THAN 50 YEARS*

50
YEARS





We are the **F1**RST

In Italy to install flat panel systems

To equip our systems with the Linux operating system

To have a real R&D department

To install anti-collision sensors

To equip the C-arms with the variable SID

To assemble multifunctional footswitches and wireless consoles

We are the first to integrate FUSION software into our systems

To propose C-arms with 3D

OVER

500 C-arms in Italy

WORLDWIDE

We export our products entirely made in Italy all over the world



eurocolumbus
C - ARM EVOLUTION

**We present to you the fourth generation
of alien e, a masterpiece of technology
and ergonomics.**

It is probably the best instrument in the cardiovascular and endoscopic field for maximum dose reduction with the best image quality ever.



eurocolumbus
CLARM EVOLUTION



alien e

*the best performing mobile
C-arm on the market.*

The fourth generation of alien e is the diagnostic suite on wheels that is unrivalled in the field of Cardiology, Vascular Surgery and Interventional Endoscopy.

EtherCAT

EuroColumbus was the first Italian company to use the new EtherCAT technology, by far the fastest of all Ethernet technologies; this is able to guarantee synchronisation times within nanoseconds. The efficiency of the Applications has also increased thanks to much shorter transition times between the various steps of the processes.

Parallel processes ensure better performance in terms of speed and precision of execution, which are very important for both image quality and dose.

Only in this way do we obtain perfect, fast and easily implementable systems.

Acquisition algorithm

Multi-Scale Analysis

The system management software, developed by the EuroColumbus R&D department using LINUX, is able to process radiological images with a maximum resolution of 3k x 3k in real time.

All images are acquired, processed and stored at 16 bits, using the best technologies available on the market.

In order to ensure full compliance with clinical dictates and not to create artefacts, no type of digital compression is carried out on the images.

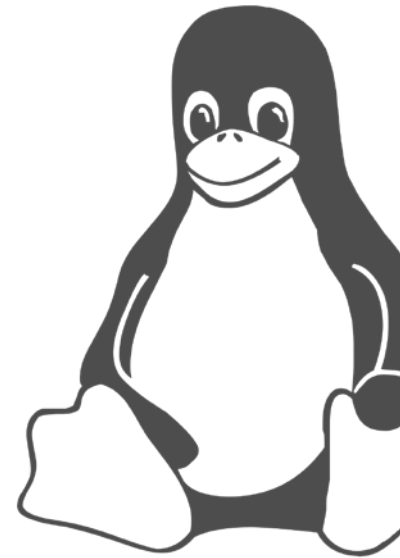

The heart of the algorithm consists of Multi-Scale pyramidal image decomposition analysis, based on the representation in terms of wavelets, which are confined both in space and in spatial frequency.

The RAW image obtained by the sensor is subjected to a series of filters and sub-sampling that make it possible to extract and separate the different levels of image information according to Gaussian and Laplacian decomposition.



Original

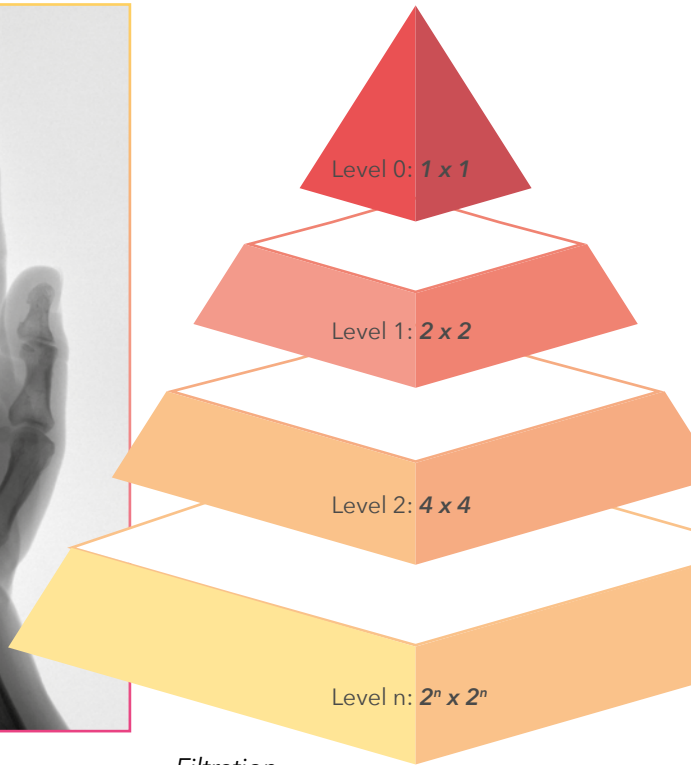

Filtration



Processed

Resolution levels: the type of technology that Euro-Columbus uses allows it to obtain images with the highest attainable level of definition



MULTILEVEL DOSE REDUCTION

Thanks to the total control at every point of the acquisition, it is now possible to obtain a perfect image and simultaneously reduce patient and operator irradiation.



Total control at every point of the acquisition means the images are perfect even acquired at the edges and not in the centre of the detector.

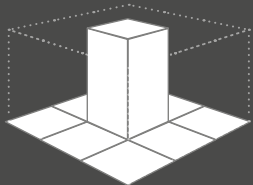

SPOT / *the past*

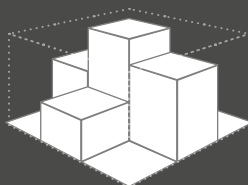

MATRIX / *in the 2000s*

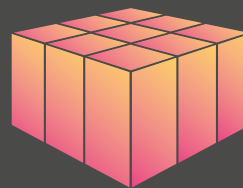

alien e

total control at every
point of acquisition

Multilevel Dose Reduction

During design, we always observe the principle of **ALARA** (As Low As Reasonable Achievable) and research and adopt specific solutions to reduce the dose of X-rays as much as possible without sacrificing the diagnostic quality of the image.

To do this, we use the EuroColumbus Multilevel Dose Reduction system that includes various levels of dose reduction involving the use of tools designed in-house.

The functions of the EuroColumbus Multilevel Dose Reduction



EDM (*Eurocolumbus Dose Management*) determines the correct dose with detection on every single pixel of the detector.



EAC (*Eurocolumbus Automatic Control*) decides the duration of the exposure even if the anatomical district is not perfectly centered.

Both functions operate in real time, thanks to a closed-loop control of "image quality - radiological parameters".



ABS (*Automatic Brightness System*) guarantees the correct brightness throughout the process.



EDS (*Eurocolumbus Dose Speed*) allows, once the perfect dose has been calculated, to vary the voltage in real time with a resolution of only 0.2 kV and, for the step current, of only 0.1 mA.



ELD (*Eurocolumbus Low Diffusion*) applies additional filters to image noise, drastically reducing the dose.



EBF (*Eurocolumbus Beam Filtration*) guarantees additional filtration of the X-ray beam with an additional motorised collimator. In addition to the basic filtration of 2.5 mm Al + 0.1 Cu, in fact, further filtration activity is guaranteed on the EuroColumbus C-arms with additional filters that automatically intervene for each body district and for each pre-set anatomical technique.

There is therefore the possibility of inserting additional filters automatically or setting them very easily.

Additional integrated filters greatly reduce the dose without affecting the very high quality of the images:



01

no additional filter



02

additional aluminum filter



03

additional fine copper filter



04

additional thick copper filter

Multilevel Dose Reduction



RDW (*Reduction Dose Wide*) the digital rotation of the images, the storage of the position of the arm and the virtual collimator, the automatic variations of pulse/frame rate and the laser pointer on the sides of the FPD and/or X-ray tube, the extractable grid, the LED light to illuminate the sterile field to make positioning on the district to be examined easier: these are all means to guarantee a significant reduction of the dose.



Even the **variable SID** (Source to Image Distance) helps to significantly reduce the dose, allowing the flat panel to be positioned closer to the patient during irradiation without having to lower the entire C-arm). It also makes it easier and more convenient for the medical personnel to work, as they are able to quickly move the detector away from the patient. The variable SID also makes it possible to use an arm with a high depth while keeping the dimensions small, in order to facilitate access of the patient and all types of movement. This minimises the risks deriving from the vertical movement of the operating bed.



LED lighth

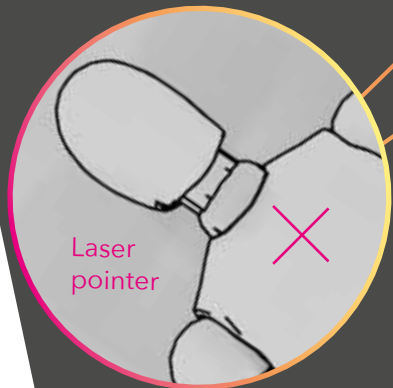

Laser pointer

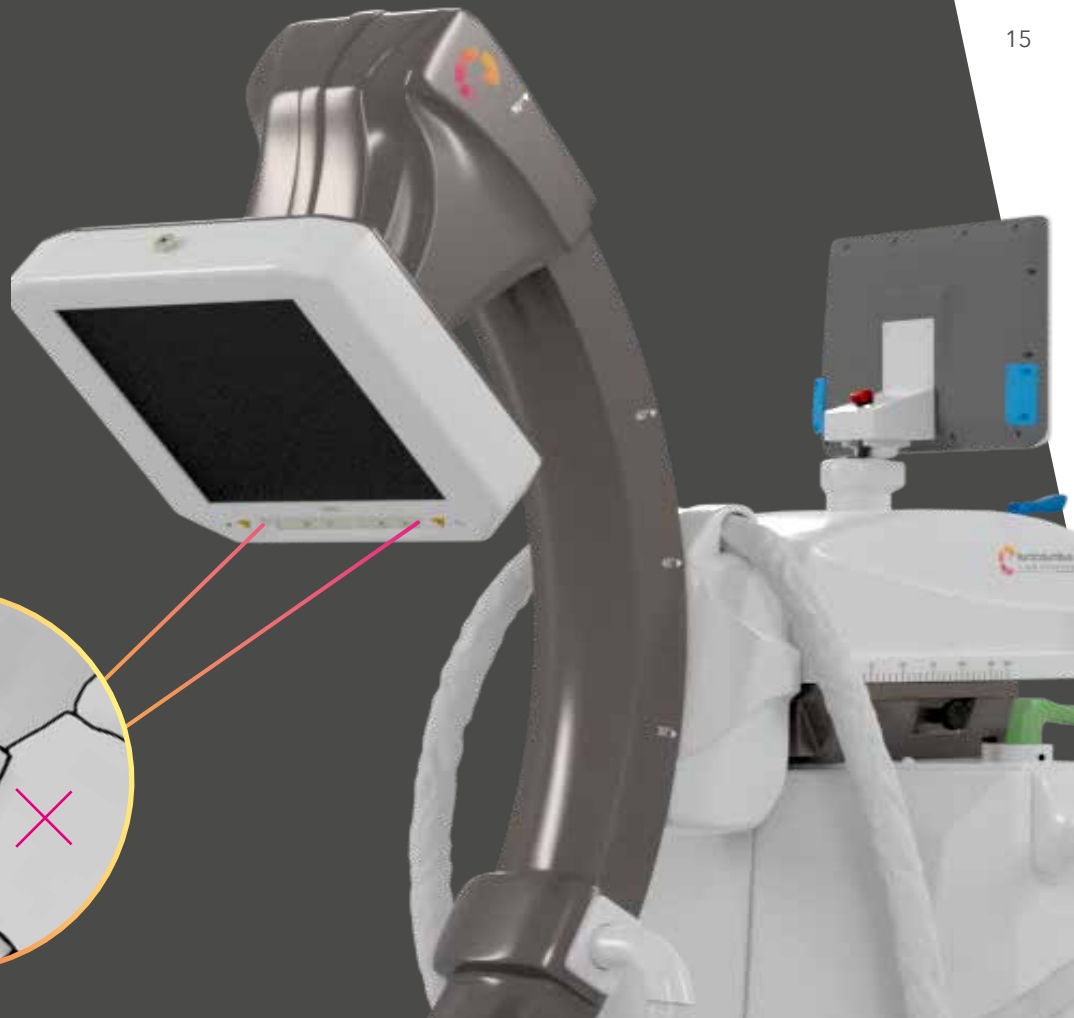



CT70T IMAGING TABLE INTERFACE SYSTEM (optional)

We were the first to create a connecting interface between the C-arms and the imaging bed, in order to manage the vertical movements of the two systems at the same time and in a way that could be ergonomic and comfortable for both the operator and the patient.

The interface is a fundamental prerequisite for working with the FUSION software.

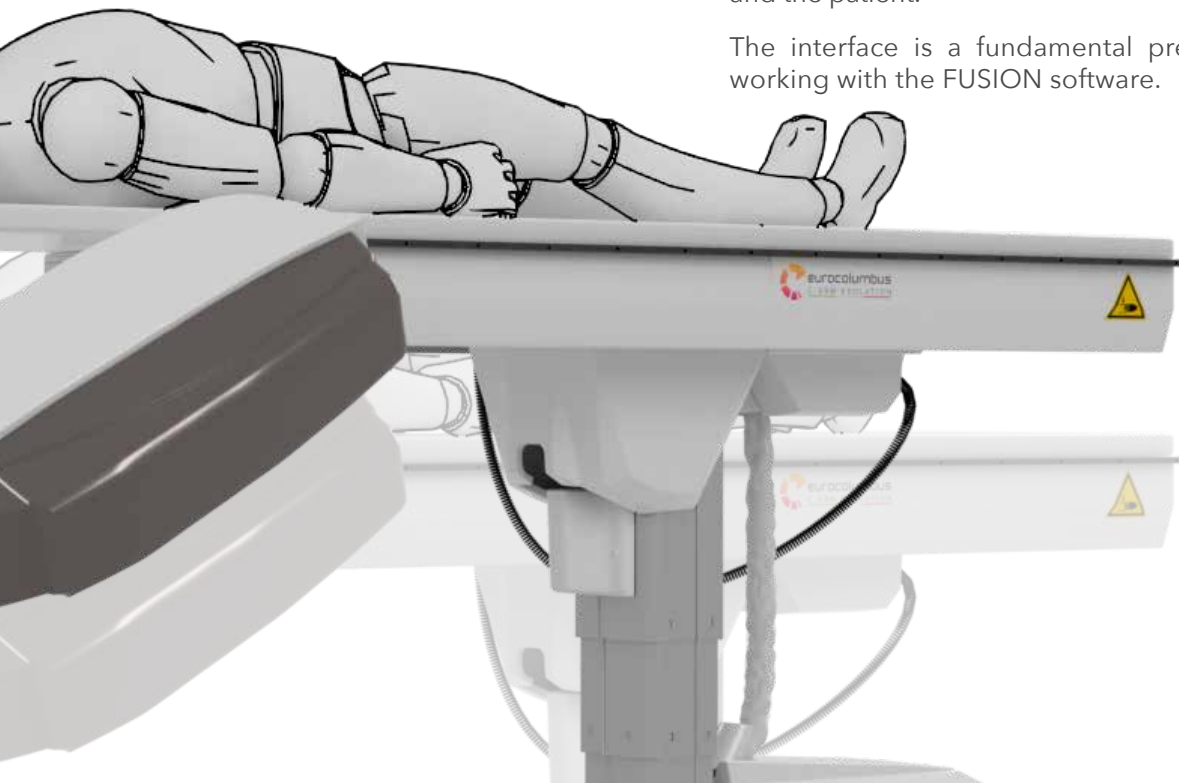

FUSION SOFTWARE *optional*

FUSION reduces the dose of the X-ray, the administered amount of the contrast medium and the duration of the surgical procedure, **significantly reducing risks for the patient.**

FUSION allows the 3D visualisation of the operating districts and in real time of the instruments (catheters, stents, prostheses, etc.) as well as the simultaneous visualisation of the blood vessels (aorta, carotid, etc.) guiding the surgeon with extreme precision in the positioning of the prosthesis.



With the use of pre-operative 3D images, FUSION minimises the need for subtractive X-ray acquisitions in real time, with a consequent reduction in procedure times, the dose of the X-ray and, last but not least, the quantity of the contrast media. EuroColumbus is the only company in the world to have developed FUSION technology integrated into C-arms: a great source of Italian pride!

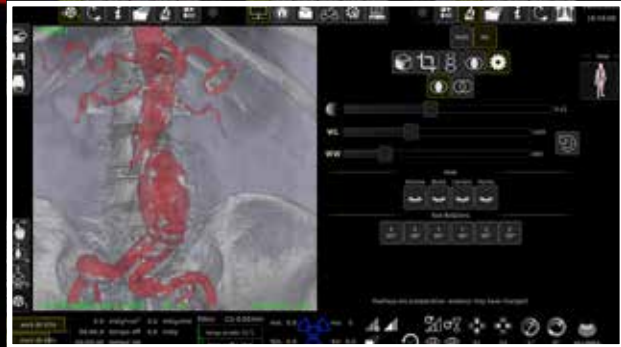
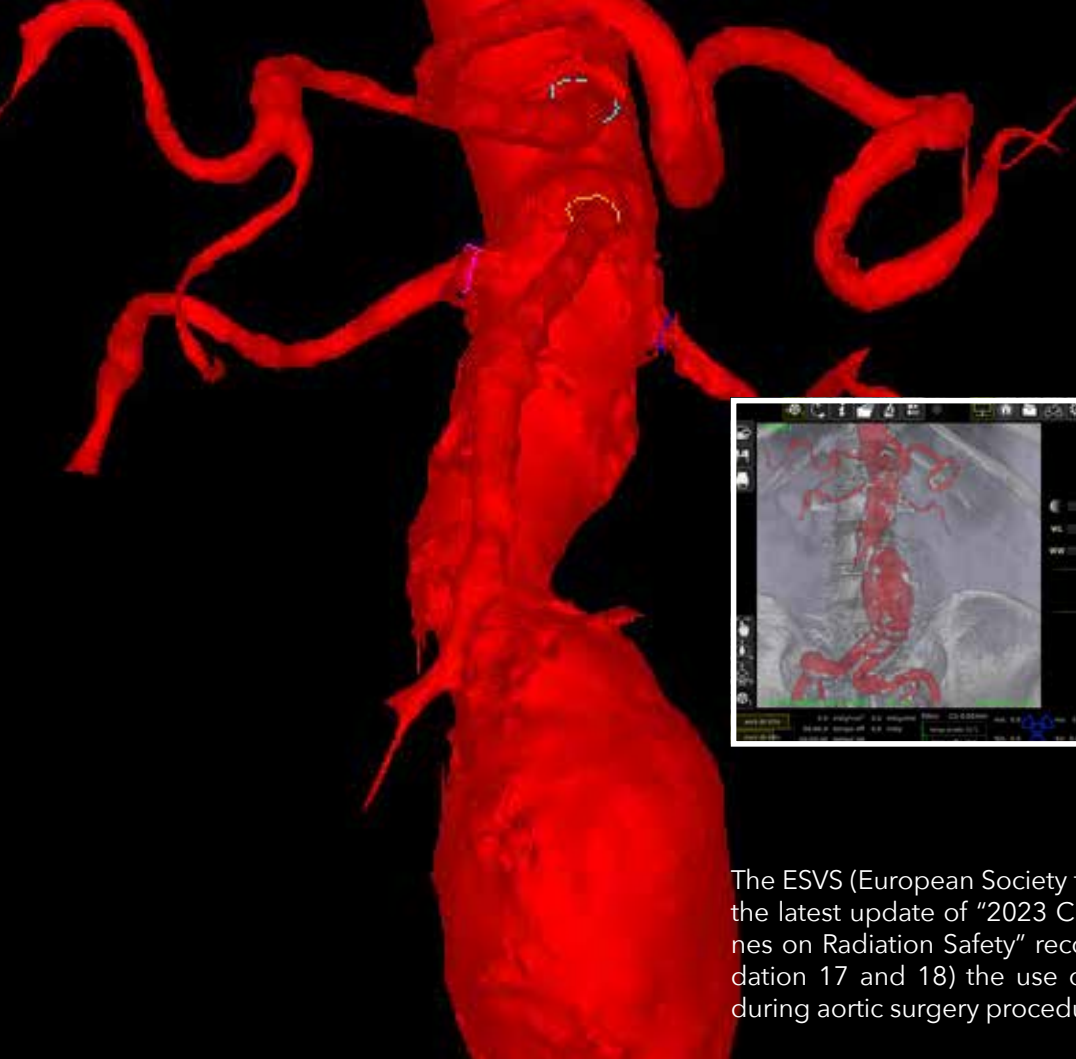

The ESVS (European Society for Vascular Surgery) in the latest update of "2023 Clinical Practice Guidelines on Radiation Safety" recommends (recommendation 17 and 18) the use of FUSION technology during aortic surgery procedures.



30 kW

25 kW

12 kW

High frequency generators

EuroColumbus developed the EPB and EPA systems specifically for clinical applications that require high instantaneous power peaks, allowing energy to be drawn from existing electrical systems equipped with 13 - 16 A electrical sockets.



EPB (*Eurocolumbus Power Boost*) is an energy reserve that stabilises the voltage and increases the performance of the inverter to avoid fluctuation during long and demanding radiological emissions.

Why don't we use the monoblock system?

Because only in this way is it possible to use tubes that have higher anode capacities and are smaller than those of monoblock technology. In a monoblock system, the heat produced by the X-ray tube is added to that produced by the generator.



EPA (*Eurocolumbus Pulse Advanced*) is a function that creates 0.5 to 30 pulses or images per second, a wide range of possibilities to guarantee images without a slow motion effect with the option of automatic variation.

Obviously, if the housing has the same declared dissipation as a system with a generator separated from the X-ray tube, the monoblock system is less efficient because the total dissipation does not cool the tube alone, but also cools the monoblock system that includes the generator.

The system with a separate generator therefore guarantees better cooling of the X-ray tube with the same dissipation of the housing.

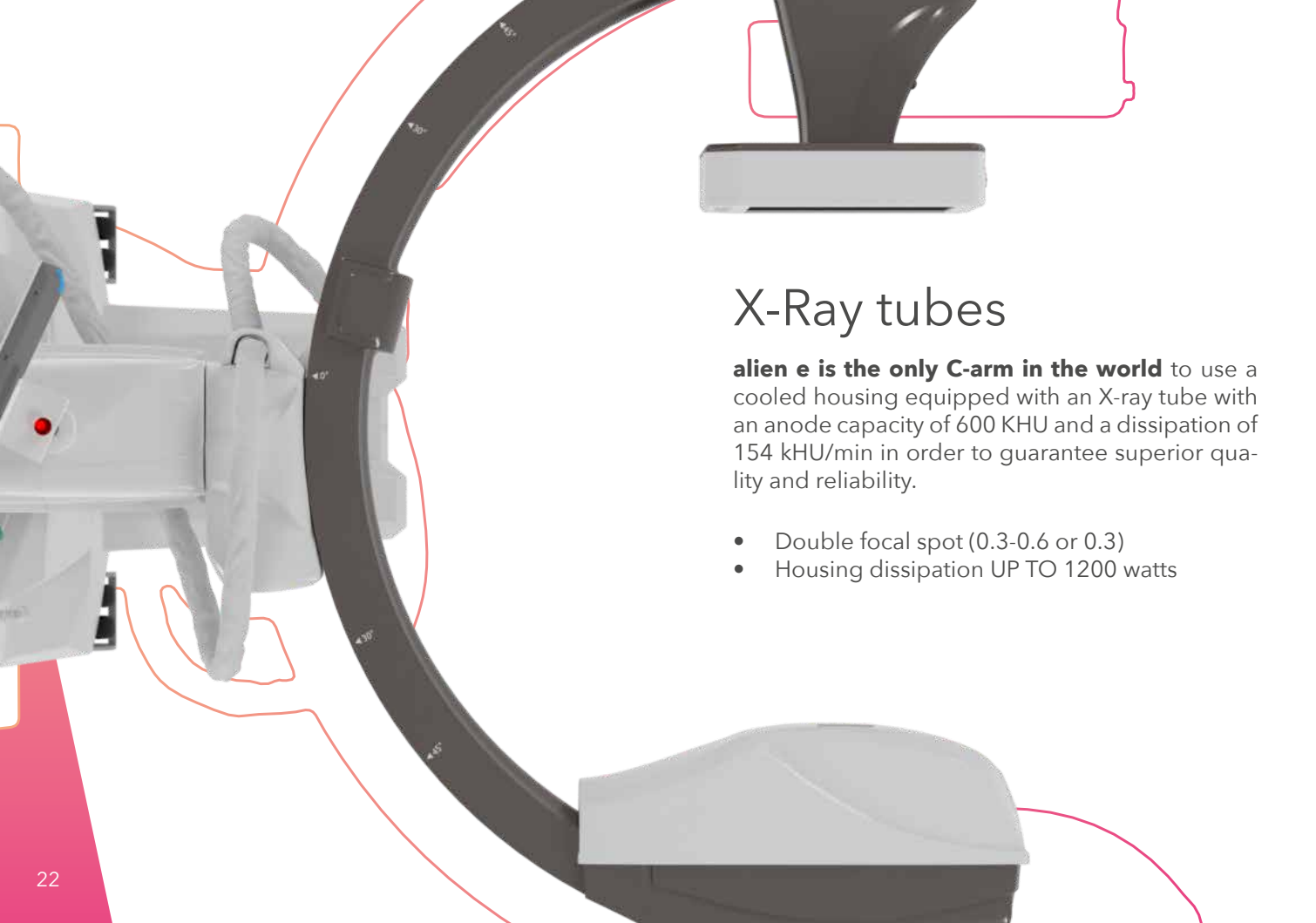

X-Ray tubes

alien e is the only C-arm in the world to use a cooled housing equipped with an X-ray tube with an anode capacity of 600 KHU and a dissipation of 154 KHU/min in order to guarantee superior quality and reliability.

- Double focal spot (0.3-0.6 or 0.3)
- Housing dissipation UP TO 1200 watts

Active Cooling System

WAD (*Water Aided Dissipation*) is an X-ray tube cooling system. Thanks to the combination of the management of the dielectric oil inside the X-ray tube, the refrigerant liquid and the advanced heat exchanger, the system does not use fans (unsuitable in the sterile medical field).

EHC (Eurocolumbus Heat Control) allows one to quickly edit the frame/sec, pulse rate and radiological and imaging parameters in real time in order to keep the heat produced under control in order to ensure optimal operation of the system and avoid overheating.

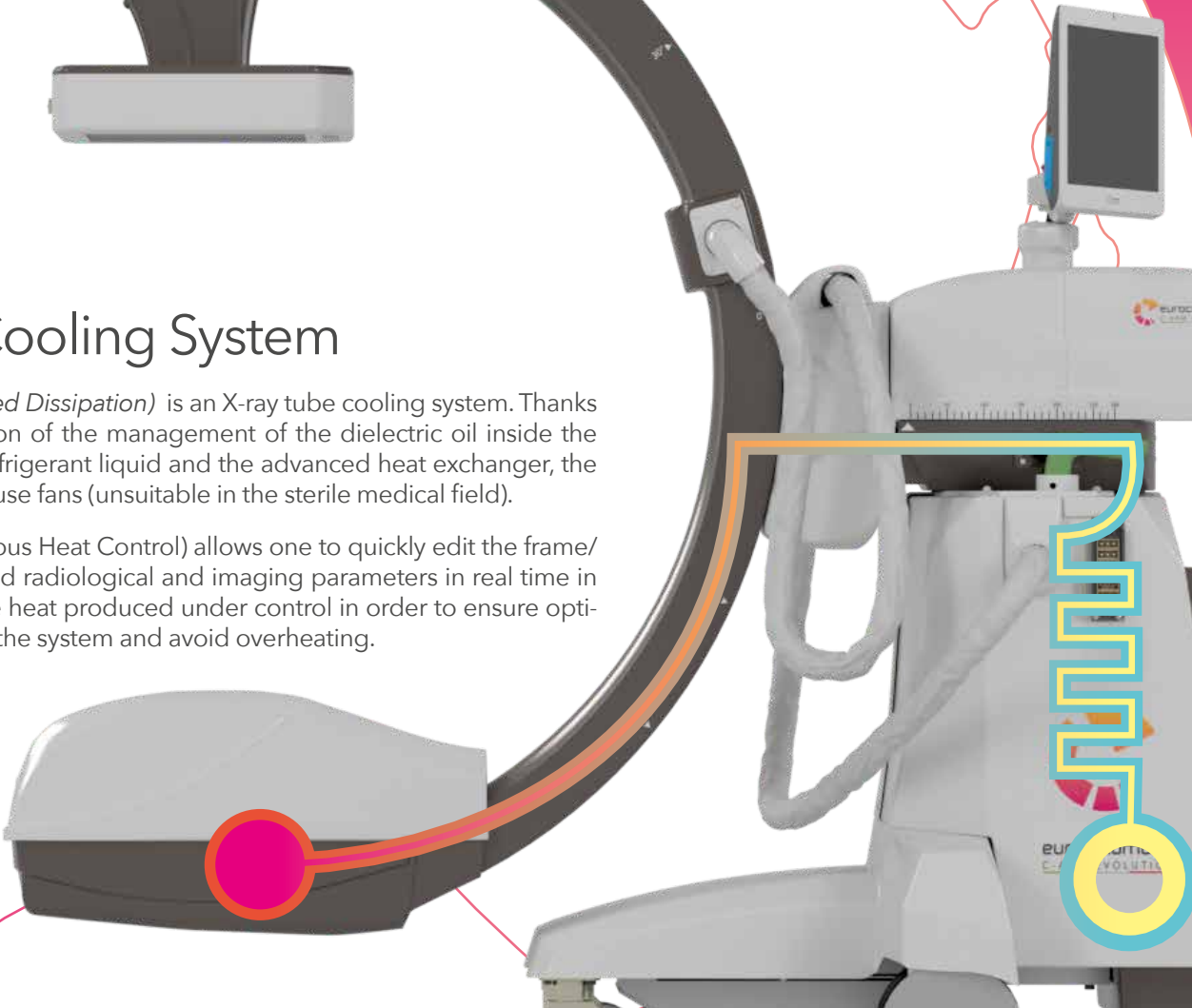

On the Operator's side:

ERGONOMICS

The twin wheels made of antistatic material and with minimal footprint on the floor, as well as the optimal weight distribution and the ergonomic handles with perfect force distribution, make alien e easy to move and operate.

These simple measures mean that the device can be positioned without difficulty, even under the operating table

alien e is perfectly balanced in every position, with the option to store up to four positions of the arm as well as the zero positions. The motorised movements can be synchronised with each other and, thanks to the FPD and RX side anti-collision sensors on the sides of the FPD and X-ray tube (the operating distance of which can be set) the chosen positions can be reached quickly and in total safety.

The position can be recalled at the simple press of a button.

Finally, alien e has colour codes for the positioning handles and to indicate the manual movements of the arm - these colours are also reproduced on the graphic interface in the interest of perfect ergonomics.





Complete control of the system using the ETS user interface

alien e is equipped with two user interfaces (of 15.6" or 18.5"). One is positioned on the C-arm and one in the rear side of the monitor trolley. This means the technician can operate away from radiation and away from the sterile field.

The ETS enables management of all the functions of the equipment: it is easy and intuitive, and designed for user recognition (in compliance with the GDPR).

It is available as a trolley option with the third ETS that allows complete control at any point in the room and, if desired, it is possible to position it at the patient's bed with a special clamp.



EPD anti-collision systems

Safety first! The **new EPD** (EuroColumbus Proximity Detection) volumetric systems can be set up in a different and independent manner for the sides of the FPD and X-ray tube.

The system detects the proximity of anatomical or metal parts and stops the arm immediately to avoid collision.

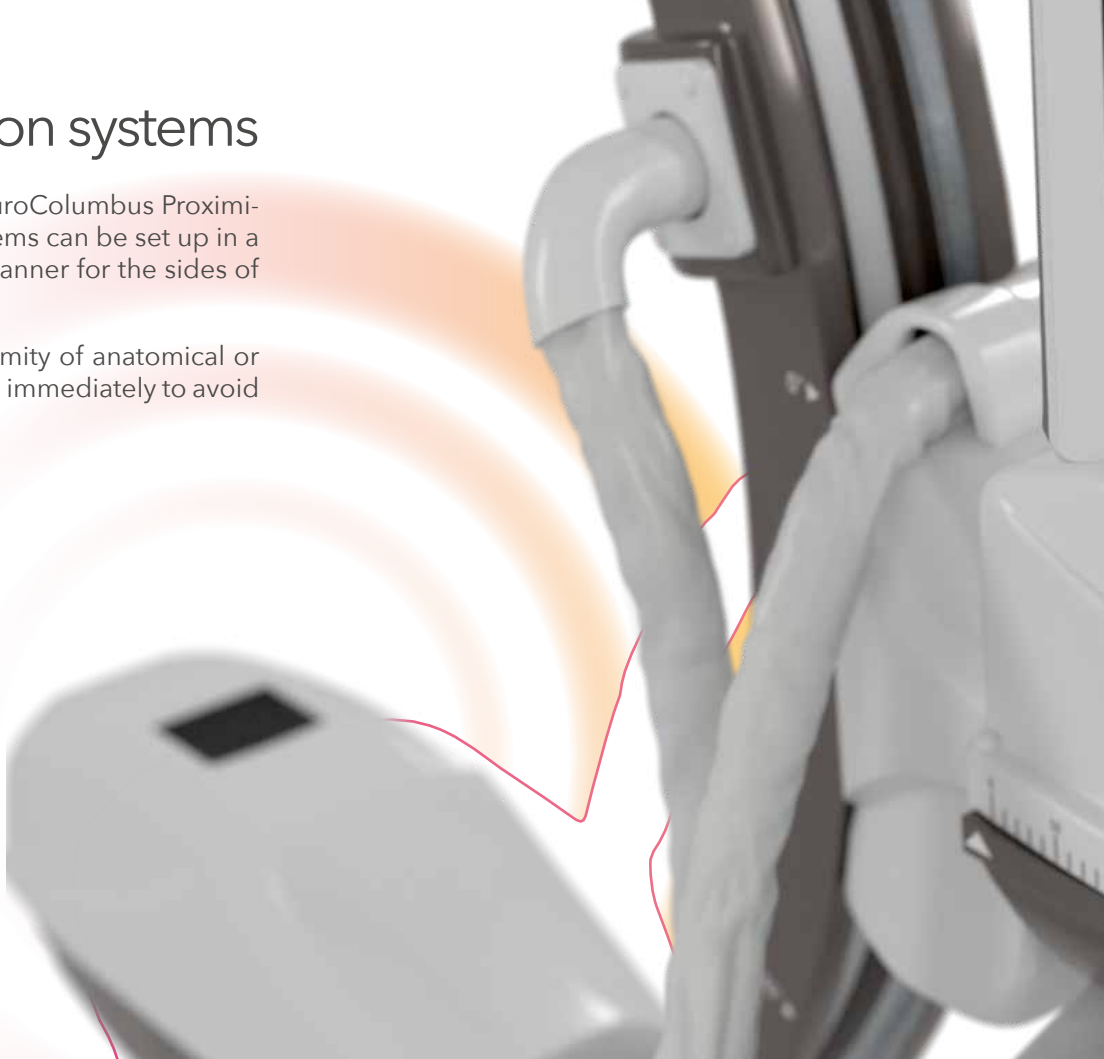

Three-step security



alien e is equipped with a smart anti-collision safety system that follows a three-step procedure:

First step: The anti-collision system is activated and stops all movements of the arm, preventing a collision.

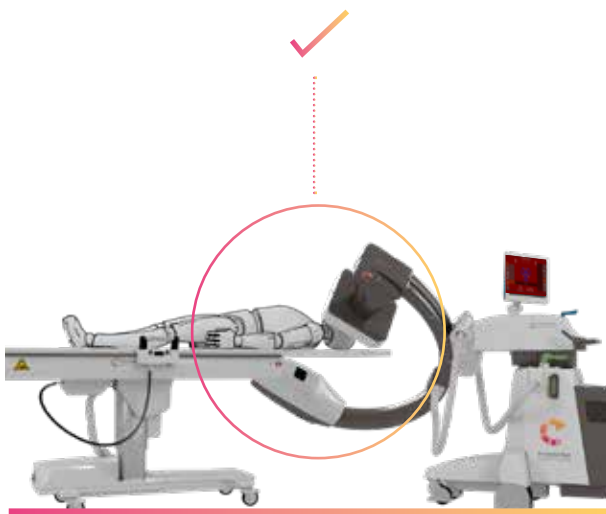

Second step: If the active anti-collision system intervenes during the emission of X-rays, all movements of the arm are stopped without interfering with the emission.

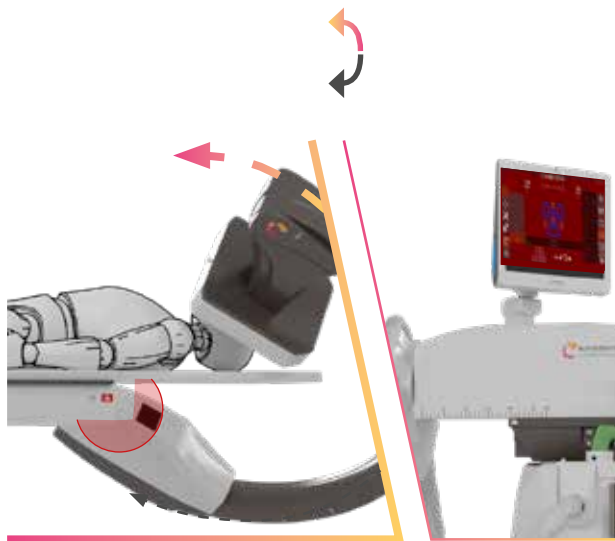

Third step: The system recognises the point of the avoided collision and activates only the buttons required to return to a safe position.

Natural isocentrism or computerised EIC:

You decide

EuroColumbus is the only system capable of having a "natural" isocentric geometry, as on fixed angiographic and hemodynamic systems and a computerised EIC system.

In fact, EIC ensures the combined and synchronised control of the 5 motorised movements: vertical, horizontal, RAO-LAO, CRA-CAU and SID, ensuring that the chosen projections are always in the isocentre.

The double choice allows you to solve any problem in the operating room relating to the precision of the required projections.

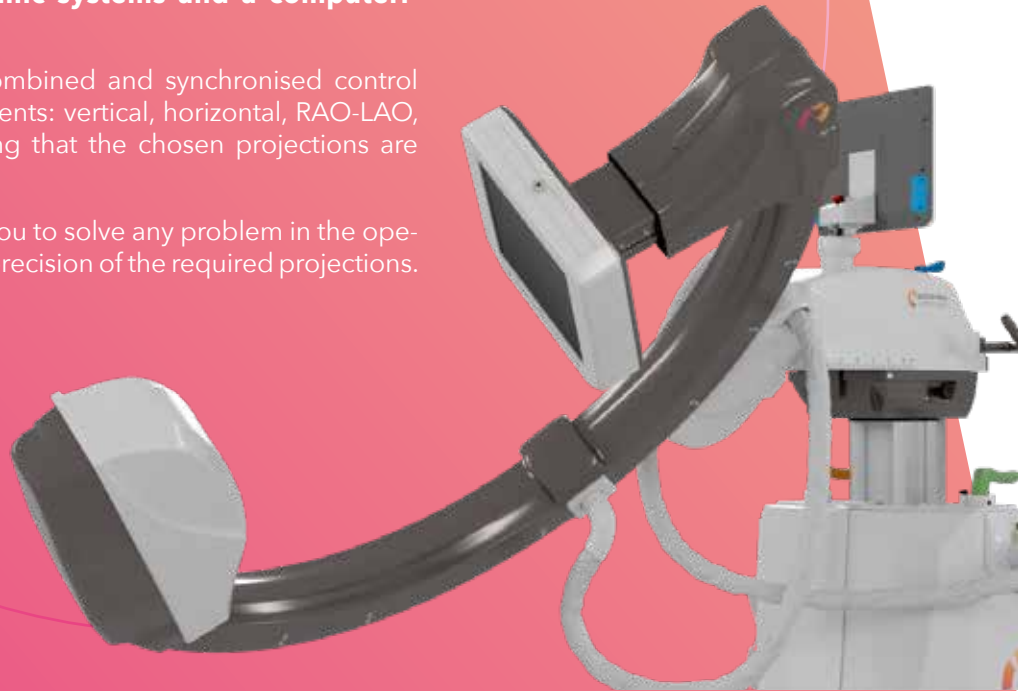

Variable SID

The vertical and angular movements are fully motorised and the SID can also be varied during the movements: up to 4 different positions can be stored, in addition to the standard ones already saved in the software, and can be recalled at any time.

This means that alien e has the same advanced functions as an expensive fixed angiograph or a stationary hemodynamic system, but at a much lower price.

Flat Panel Detector

Eurocolumbus' truly revolutionary product is the proprietary frame grabber of up to 10 GB that can manage images up to 3K x 3K. We only use a high quality FlatPanel with:

- High DQEs
- Limited pixel pitch
- Technology: Amorphous silicon or CMOS or IGZO

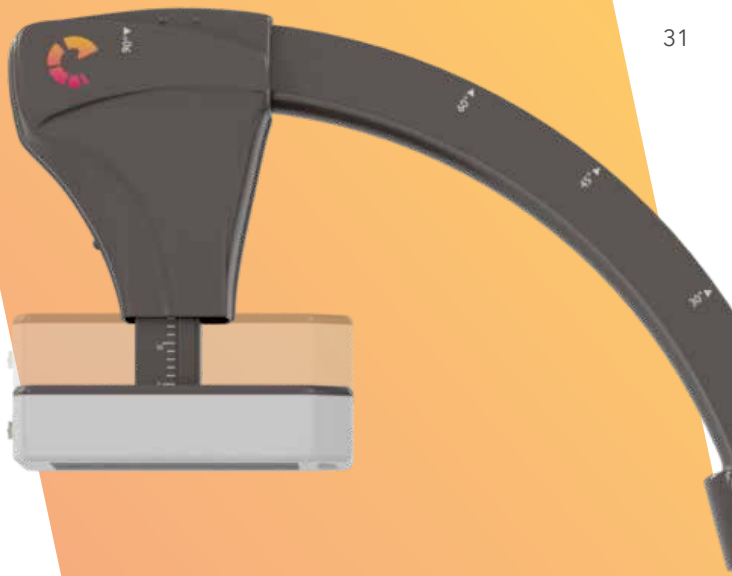

Ergonomic monitor trolley

Designed to meet the operator's needs for sterility and ergonomics, EuroColumbus' new trolley measures less than 55 centimetres on each side.

The trolley has large diameter and twin wheels to ensure maximum manoeuvrability. These wheels are equipped with cable sweepers and made of antistatic material.

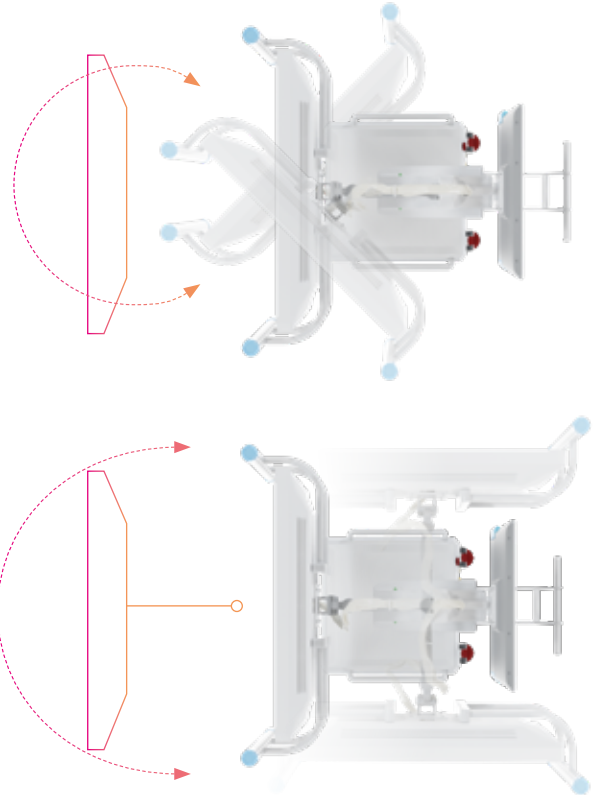

Monitors

for the best possible experience

We are the first to use only 4K monitors.

Our monitors measure 27" or 32", are protected against accidental shocks, and can be adjusted vertically, with a motorised movement, as well as horizontally and laterally.



WIRELESS WORLD

Read all about our Wireless options for maximum manoeuvrability, maximum hygiene and minimum footprint

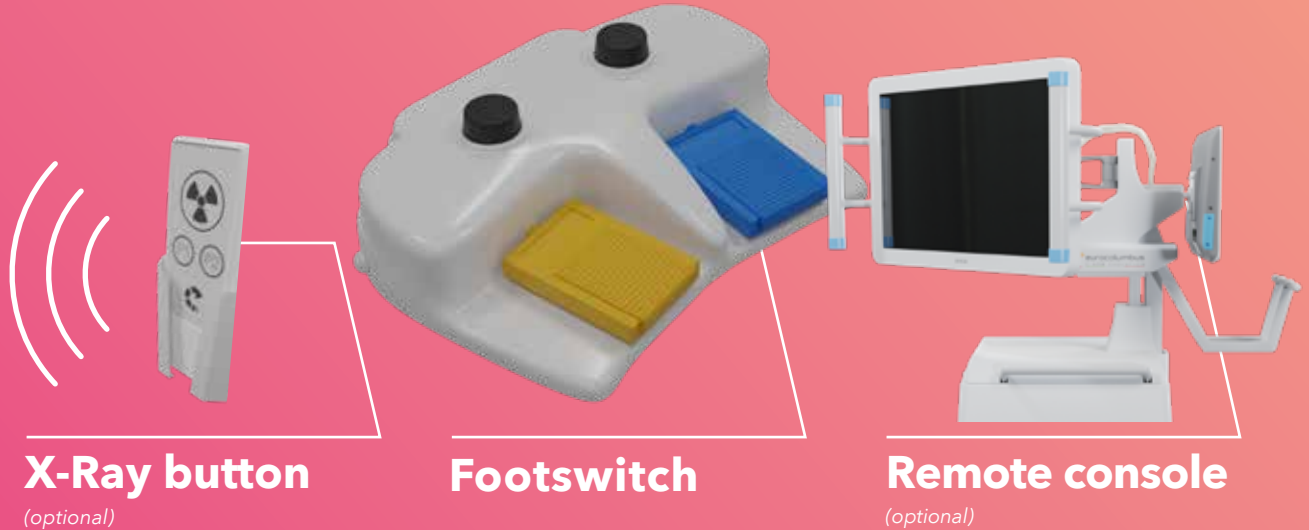

Additional monitors

(optional)

Request the additional **55" 4K** split screen monitor to receive all images from the C-arms and other sources (up to 4) even wirelessly.

The power cable is retractable to ensure maximum comfort when moving around the room.



WLAN

Thanks to the WLAN function it is possible to instantly and securely transfer data, patient examinations and images from the C-arm to the hospital or Clinic PACS (Picture Archiving and Communication System).





The image shows a close-up of a medical C-arm device. The main body is white with a logo in the upper left corner. The logo consists of a stylized figure in a circle, colored with a gradient from orange to red. To the right of the logo, the text "eurocolumbus" is written in a lowercase, sans-serif font. Below that, "C-ARM EVOLUTION" is written in a smaller, uppercase, sans-serif font, with a thin red line underneath. In the foreground, there are several control handles: a grey one, a teal one, and a yellow one. The background is blurred, showing more of the device's structure.

eurocolumbus
C-ARM EVOLUTION

TAKE AWAY

Why choose alien e

alien e is the only one in the world to have all of the following:

- 600 KHU tube with anode dissipation of 154 KHU/min
- Natural and computerised isocentric C-arm
- Variable SID and 5 synchronised axes
- Active anti-collision systems with the possibility of setting the intervention distance
- Wireless world, for maximum control: wireless connections with multifunctional footswitch, remote console and external monitors
- FUSION software integrated
- Full HD resolution ETS touch monitor on a handy mini trolley
- Linux operating software, the true real time



4.0

We manage assistance in an innovative way, respecting privacy and in line with the GDPR directives, following the “enterprise 4.0” approach.

A server, installed at the Eurocolumbus assistance centre, can connect via the web to radiological equipment in hospitals around the world.

The assistance center will constantly monitor the correct functioning of the equipment around the clock and in real time and, if necessary, will intervene remotely on the software to solve or prevent problems.

Our engineers will interact in multimedia mode with hospital or technical staff to provide support or instructions, for example in the event of hardware failures.

A hand is shown pointing at a central green hexagon containing the word "COMPLIANCE" in white capital letters. The background is dark with a grid of white hexagons. Other icons visible include a hand holding a checkmark, gears with a checkmark, a clipboard, a target, and a scale of justice.

COMPLIANCE



eurocolumbus
C-ARM EVOLUTION

A Made in Italy story

Eurocolumbus was founded in 1972 and began to grow exponentially as from 2004, when the Flat Panel Detector on C-arms was introduced for the first time in Italy. In the following years the products were fully updated and renewed, maintaining the original characteristic which was based on an iso-centric C-arm,

motorised and made safe thanks to anti-collision sensors and a generator separate from the X-Ray tube. Eurocolumbus is still today the only Italian

company producing C-arms that can claim to have its own, proper in-house Research and Development centre. The equipment is entirely designed and produced in the Milan factory (Italy). In 2016, Eurocolumbus entered into a partnership with an important group that invests a very high percentage of its turnover in Research and Development in Italy.

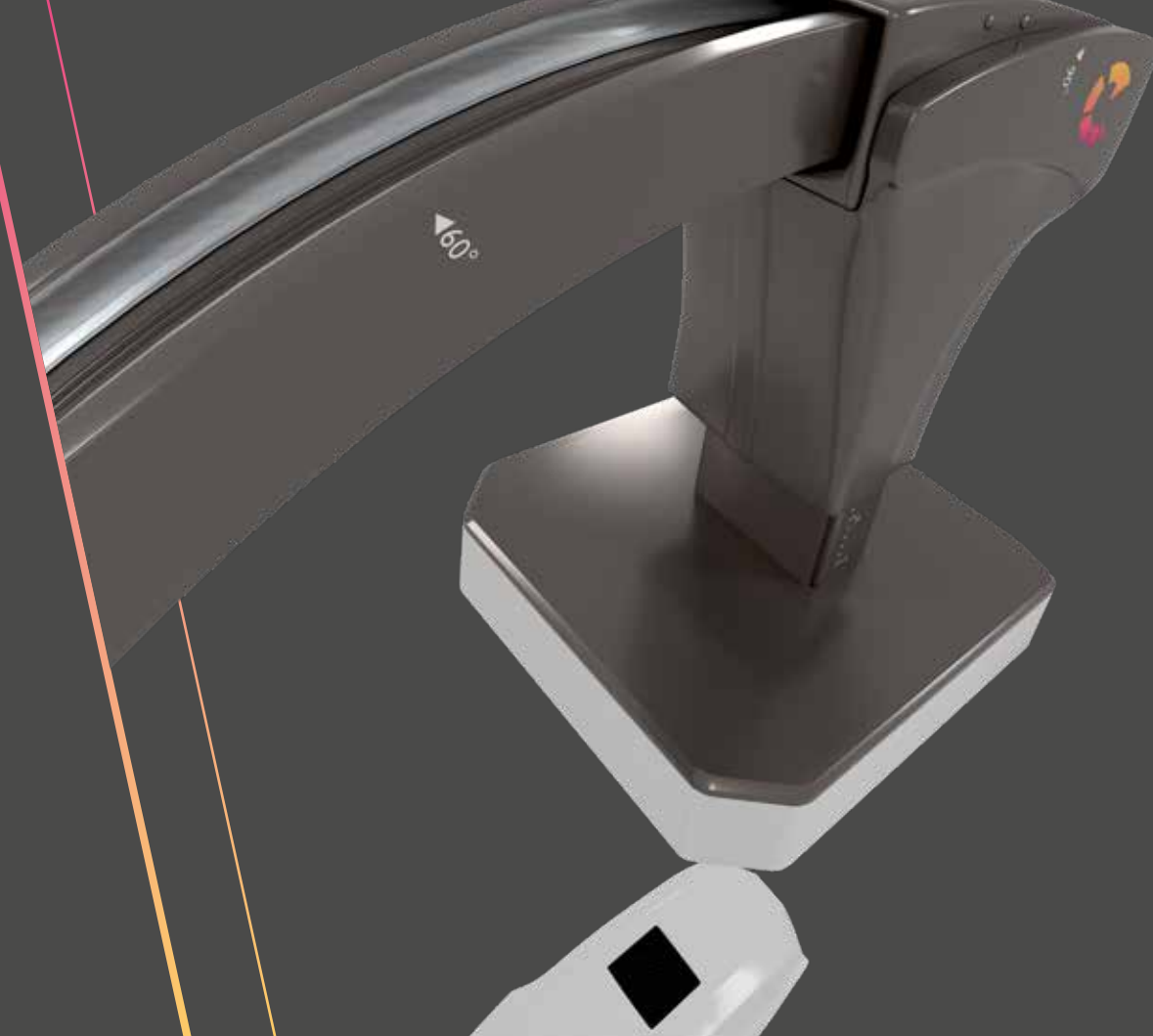





alien e
RECHARGE

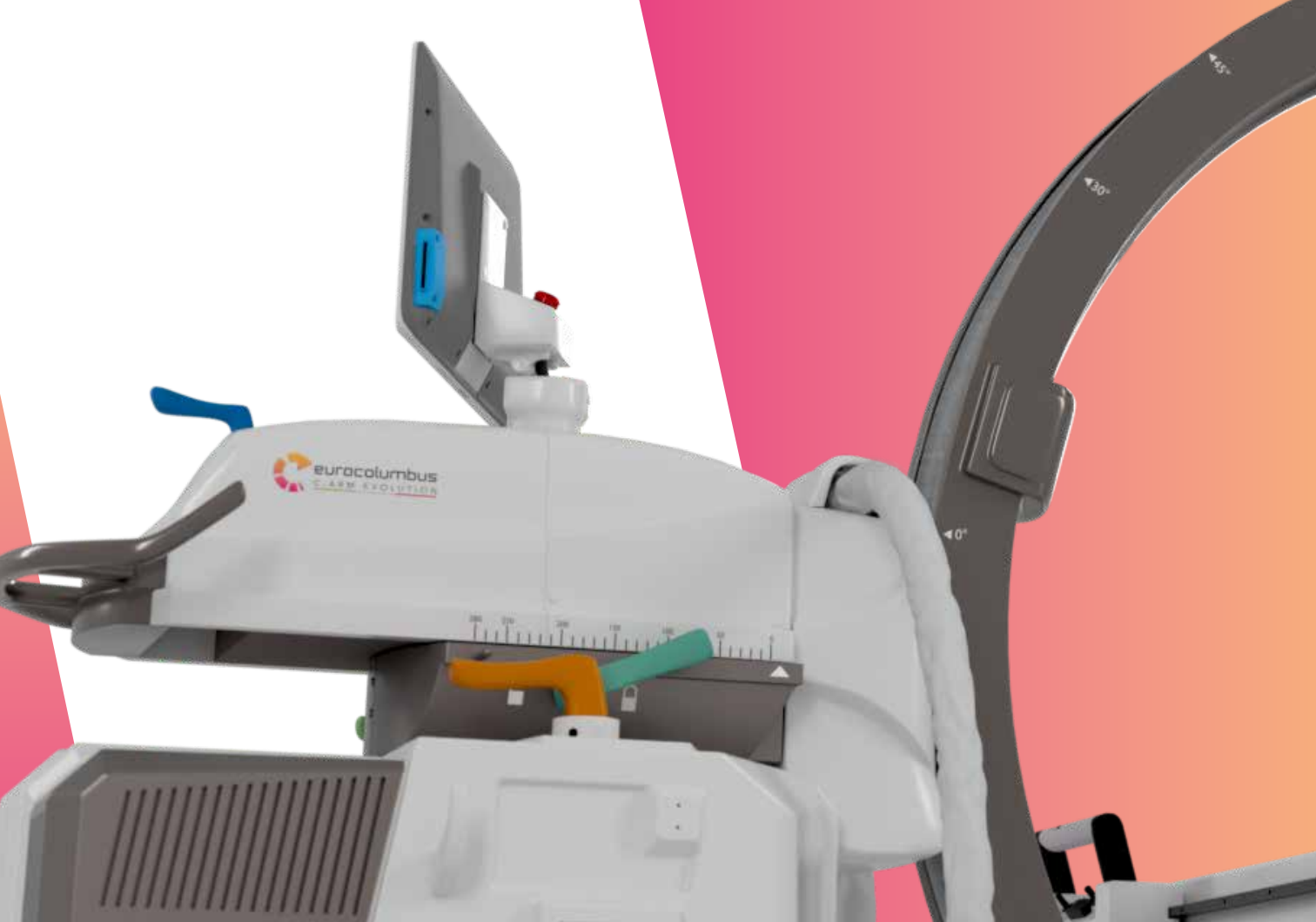



THE LATEST INNOVATION FROM OUR R&D DEPARTMENT

alien e - Introducing the wireless and hybrid configurations

The most complete solution to your needs - Different setups,

SAME POWER

25_{kw}



The different combinations modify the ergonomics of the machine according to the needs of the technicians or according to the medical specialty.



HYBRID

The arch is connected to the power grid, there are no cables between the arch and the trolley but the trolley is connected to the electric socket.



alien^e the most ergonomic and full-featured on the market.







eurocolumbus
C-ARM EVOLUTION

Eurocolumbus srl
via Filargo, 36
20143 Milano, Italy
www.eurocol.it